

PAINT BORER

518 USB

PAINT BORER

518 MC

PAINTXPLORER

548

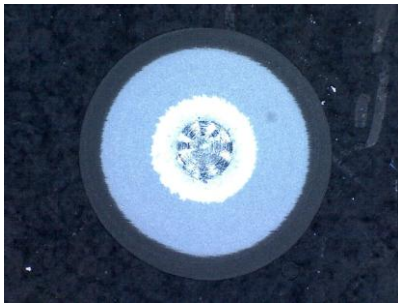

PAINT BORER 518 USB

**Thickness measurements
in accordance with
the standardised
wedge cut method**



PAINT BORER 518 MC



PAINTXPLORER 548

testing equipment for quality management

Technical Description

**ISO 19399
ISO 2808
ASTM D 4138
ASTM D 5796**

**Thickness measurement
of all coatings on any
substrate
Measurement of
individual layers of a
multi-layer coating**

**Universal Thickness
Measuring Instrument**

Thickness Measuring Instrument PAINT BORER 518 USB



The Measuring Principle

The **PAINT BORER 518 USB** operates in accordance with the standardised wedge cut method in which the specimen is cut in a defined angle. With a high-resolution digital microscope (50 x magnification) with integrated light (8x white LED, adjustable), equipped with a 2 million pixels CMOS image sensor and scalable precision measurement, a direct image capture directly from the object is made. With the new 518 USB, connectable to a PC, laptop/WINDOWS-tablet, a convenient digitally supported way is given for visual recognition/detection/measurement and documentation. An appropriate software is included.

The Measuring Instrument

The **PAINT BORER 518 USB** is a very compact instrument. All the principal components - the drilling device, the digital microscope, the specimen illumination and the battery - are enclosed in a sturdy housing.

A slide moving on horizontal slide-ways houses the drill and microscope and gives the **PAINT BORER 518 USB** its particular feature: the instrument itself does not have to be moved for measuring after drilling.

The drill is spring mounted in the slide so that it can be pressed down onto the specimen with minimum force, the drill being switched on automatically when this is done. The carbide drills are easy to exchange and supplied with different accurately maintained cutting angles for 3 standard measuring ranges.

The light button on the backside of the **PAINT BORER 518 USB** can be set for either continuous light as well as three levels of illumination or interrupted illumination to prolong battery life. A 9-volt rechargeable battery is employed; mains operation with the charging unit is possible.

Optionally, a specimen table for fixation/measurement of small parts is available (details see page 6).

The Operation

The coating thickness measurement with **PAINT BORER 518 USB** is very simple: Apply a contrast mark (felt tip pen) and place the measuring instrument on the specimen. Move the drill into position over the test point and lower it causing the motor to switch on. Drill the coating through to the substrate. Move the microscope over the hole and switch the lamp on.

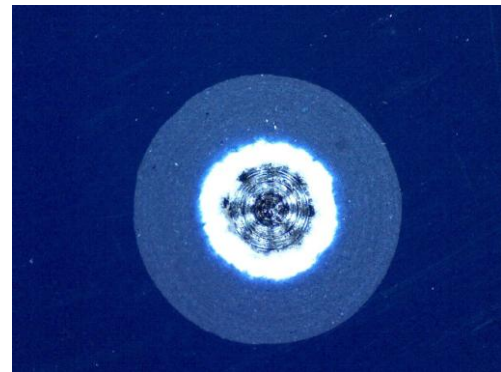

The image is shown on the display of the connected PC / Laptop / WINDOWS-Tablet and can be saved for further use/measurement/documentation. The contrast for the comfortable present imaging sharpness is already preset accordingly.

Use the mouse for the cursor to mark the appropriate relevant positions - the center of the drilled hole as well as all visible layer transition lines.

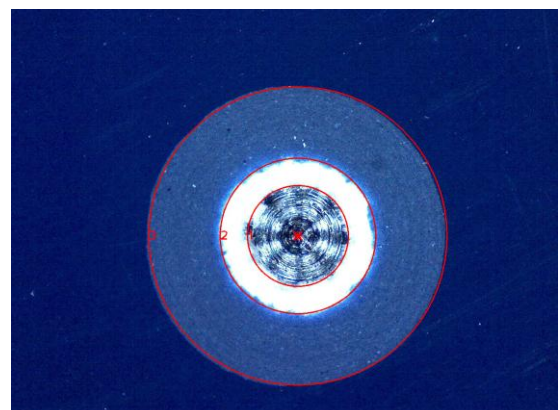

Depending on the drilling angle, by a tangential function the selected intervals can now be assigned due to the respective layer thickness of the obliquely vertically cut areas.

Thus, with only one bore, every single layer as well as individual layers of multi layers can be captured and measured.

The necessary formula works and all the relevant controls are already part of the standard software.

Also ellipsoid holes on one-dimensionally curved geometries are already considered in a reasonably feasible manner.

For improvement of the contrast within the visual determination/recognition of the layer transition lines, the display of the hole is by choice in black & white as well as also in a selection of other different colors possible (see examples).

As an additional great advantage to avoid communication-given information errors from user to user, customer to supplier, supplier to customer, etc., there's the possibility of storing/logging the entire relevant measuring thread with data and image.

Examples:

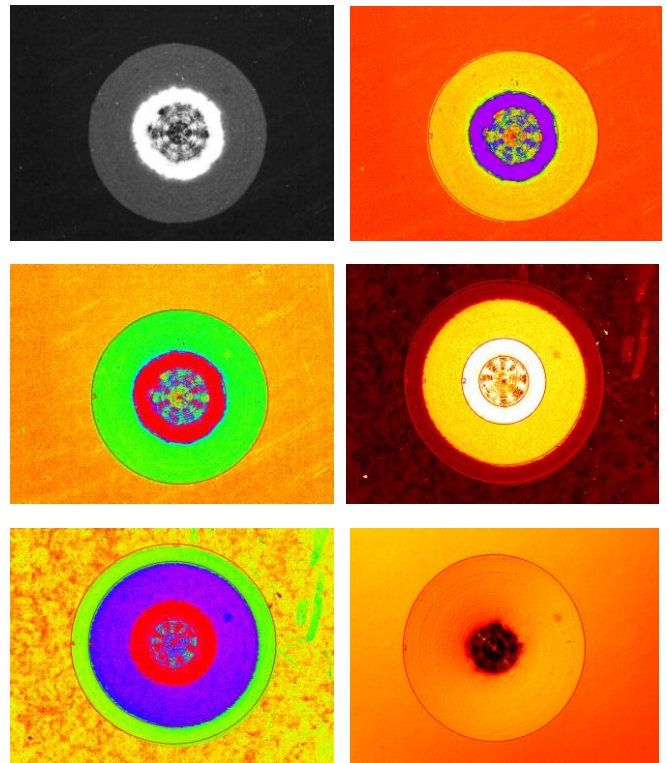

ERICHSEN "518"

ERICHSEN
since 1910

Mausverhalten: klicken ziehen
Bohreranzwahl: 8.5 (5)

Bild laden Bild aufrufen

Mittelpunkt

Kreis 1

Kreis 2

Kreis 3

Kreis 4

Kreis 5

Kreis 6

Messdatum, ~zeit
YYYY-MM-DD hh:mm:ss

Probe:

Material:

Kommentar:

Aufbau:

Substrat:

Schicht	Name	Schichtdicke [µm]
1	Haftvermittler	52
2	Grundierung	145
3	Füller	0
4	Basecoat / Decklack	0
5	Klarlack	0

Quit

The screenshot shows the ERICHSEN software interface. On the left is a control panel with various settings and a table of layer data. On the right is a large image of a hole cross-section with three red circles labeled 1, 2, and 3, and a red 'X' marking the center point.

Thickness Measuring Instrument PAINT BORER 518 MC



PAINT BORER 518 MC

The Measuring Principle

The **PAINT BORER 518 MC** operates in accordance with the standardised wedge cut method in which the specimen is cut at a defined angle. From the projected width of the cut face the layer thickness can be calculated making use of a simple geometrical relationship. With **Model 518 MC** the damage to the coating is limited to a small conical hole as illustrated in the sectional view. In the measuring microscope a system of concentric circles is visible and from the difference in the radii of the circles which are measured using the measuring microscope, the film thickness can be calculated by multiplying with a known factor.

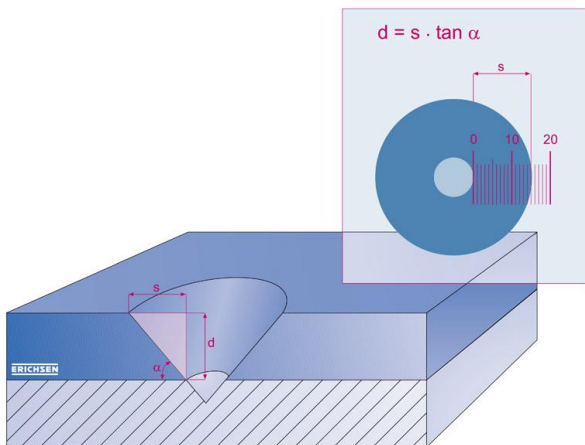

The Measuring Instrument

The **PAINT BORER 518 MC** is a very compact instrument. All the principal components - the drilling device, the measuring microscope, the specimen illumination and the battery - are enclosed in a sturdy housing. A slide moving on horizontal slide-ways houses the drill and microscope and gives the **PAINT BORER 518 MC** its particular feature: the instrument itself does not have to be moved for measuring after drilling.

The drill is spring mounted in the slide so that it can be pressed down onto the specimen with minimum force, the drill being switched on automatically when this is done. The carbide drills are easy to exchange and supplied with different accurately maintained cutting angles for 3 standard measuring ranges. The measuring microscope with a magnification factor of 50 has a measuring scale with 100 lines so that a resolution of 1% is obtained irrespective of the measuring range.

The light button on the backside of the **PAINT BORER 518 MC** can be set for either continuous light as well as three levels of illumination or interrupted illumination to prolong battery life. A 9-volt rechargeable battery is employed; mains operation with the charging unit is possible.

Due to the mobility of the microscope into two directional axes (turned by 90° from one another) and with the possibility of turning the scale, the **PAINT BORER 518 MC** is especially suitable for the evaluation of elliptical holes that arise with curved/tilted specimens.

The Operation

The coating thickness measurement with **PAINT BORER 518 MC** is very simple: Apply a contrast mark (felt tip pen) and place the measuring instrument on the specimen. Move the drill into position over the test point and lower it causing the motor to switch on. Drill the coating through to the substrate. Move the microscope over the hole and switch the lamp on. Count the number of scale marks between the base material and the contrast mark and multiply this value by the scale factor which gives the measuring results.

Special applications (individual layers of a multi-layer system, measurements on curved/tilted specimens) are dealt with in the operating instructions.

Optionally, a specimen table for fixation/measurement of small parts is available (details see page 6).

Thickness Measuring Instrument PAINTXPLORER 548



PAINTXPLORER 548 with drilling stand

The Measuring Principle

The **PAINTXPLORER 548** functions in accordance with the same measuring principle of the standardized wedge cut method as the **PAINT BORER 518 MC/518 USB**.

The Measuring Instrument

The **PAINTXPLORER 548** has been developed to extend the range of the application of the **PAINT BORER 518 MC/518 USB**, especially targeting sensitive drillings, particularly into rigid/brittle materials. It is possible that, already at minor eccentric irregular running of the drill used or of its centre axle, such materials can be subject to breaking off of the cutting edges including chipping off, leading afterwards during the optical measurement with the microscope also to limitedly definable transitions between the layers to be measured.

To minimise these limitations the **PAINTXPLORER 548**, a convenient tabletop unit, is equipped with an improved rotating/sliding high precision axle-bearing device. Although the application can be considered as mobile in the range of the length of the mains cable, it is nevertheless the question of a laboratory equipment. It can either be held in hand or used in connection with the measuring stand that is included in the scope of supply.

The appropriate measuring microscope is not integrated in the housing, as for the **PAINT BORER 518 MC/518 USB**, but is available separately, if required, as a self-contained component (e. g. for the evaluation of damages of lacquers, corrosion creep, pores etc.) which results in the slender handy design of the **PAINTXPLORER 548**.

The Operation

In principle, the **PAINTXPLORER 548** is used in the same way as the **PAINT BORER 518 MC/518 USB**:

- Application of a contrast mark.
- Placing the instrument onto the specimen, positioning the drill directly above the test point. When using the stand, position the test point on the specimen directly beneath the drill. Then fix the specimen from underneath by rotating the pressure plate.
- Drilling through the layer to the substrate.
- Carrying out the measurement with the help of the microscope considering the scale factor.

The geometry of the specimen admissible for the coating thickness measurement with the **PAINTXPLORER 548** depends on whether the drilling unit is used with or without drilling stand.

Configuration	Geometry of the specimen		
	Length (mm)	Width (mm)	Thickness (mm)
Drilling unit only	min. 40	min. 80	optional
Drilling unit and drilling stand	min. 10	min. 15 max. 110	max. 20

Accessories (optional) for models 518 MC / 518 USB:

Specimen platform for fixation/measurement of small parts consisting of: Base stand, counter plate with drill window, inflatable rubber impression ball with ergonomic Peleus ball and 3 flexible hard foam cushions.

The small specimen to be measured is fixed after manual positioning on the flexible hard foam cushion under the drill window of the counter plate.

Minimum sample size for small parts: ≥ 17 mm (whether round, square or otherwise shaped; has to be considered in relation to the drilling and measuring opening of the specimen table !)

The circular executed drilling and measuring opening of the counter plate has a diameter of 15 mm.

Its edge holds the flat surface of the small specimen to be measured, pressed from below, at the correct height level for drilling as well as for focusing and measuring by the measuring microscope.

The upper counter plate with drill window can also be used separately as a free positioning aid (just loosen 4 screws) to set up the PAINT BORER 518 MC or 518 USB on surfaces that would otherwise not be comfortable to set up resp. use due to their too small dimensions (drilling & measuring).

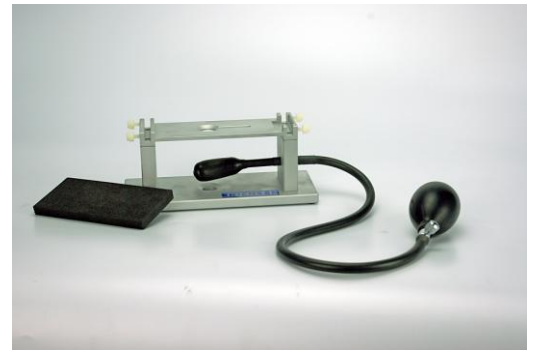

Technical Data

PAINT BORER 518 USB

Dimensions (L x W x H):	155 x 55 x 110 mm
Net weight:	approx. 850 g
Mains supply (optional):	
Accu	6F 22
Battery (9V)	6LR 61
Plug-in power pack	(100 - 240) VAC, (47 - 63) Hz 18 VDC / 0,8 A
Image sensor:	2 MegaPixels (interpolated to 5M)
Light source:	8 LED, adjustable
PC interface:	USB 2.0 or 3.0
Magnification ratio:	50x
Photo format:	PNG
Operation system:	Windows2000/XP/Vista/7/8/10/11
OSD language:	German, English

Technical Data

PAINT BORER 518 MC

Dimensions (L x W x H):	155 x 55 x 110 mm
Net weight:	approx. 850 g
Measuring resolution:	1%
Mains supply (optional):	
Accu	6F 22
Battery (9V)	6LR 61
Plug-in power pack	(100 - 240) VAC, (47 - 63) Hz 18 VDC / 0,8 A
Min. dimensions of sample (518 USB/518 MC):	
without specimen table	approx. 150 x 25 mm
with specimen table (small parts)	≥ 17 mm

Technical Data

PAINTXPLORER 548

Drilling Unit

Dimensions (H x W x D): 145 x 70 x 40 mm

Net weight: approx. 600 g

Number of revolutions of the drill: approx. 500 rpm

Mains supply

Plug-in power pack: (100 - 240) VAC, (47 - 63) Hz
18 VDC / 0,8 A

Drilling Stand

Dimensions (H x W x D): 280 x 190 x 120 mm

Net weight: approx. 3.2 kg

Measuring Microscope (456-50)

Dimensions (H x W x D): 105 x 130 x 40 mm

Net weight: approx. 150 g

Magnification factor: 50

Measuring range: 2 mm

Scale division: 20 μm

Power supply: battery (9V) 6LR 61

Drills for Models 518 USB / 518 MC / 548:

Drill	No. 2 ¹⁾	No. 5 ²⁾	No. 4 ¹⁾	No. 3 ¹⁾	No. 1 ¹⁾
Measuring range	up to 200 μm	up to 300 μm	up to 500 μm	up to 1000 μm	up to 2000 μm
Scale factor (f) (Mod. 518 MC/548)	2 $\mu\text{m}/\text{sc.div.}$	3 $\mu\text{m}/\text{sc.div.}$	5 $\mu\text{m}/\text{sc.div.}$	10 $\mu\text{m}/\text{sc.div.}$	20 $\mu\text{m}/\text{sc.div.}$
Cutting angle (α)	5.7°	8.5°	14.0°	26.6°	45°
$\tan \alpha$	0.10	0.15	0.25	0.50	1.0
Geometry	two-edges				single-edges
Head \varnothing	5 mm				
Material	carbide				



¹⁾ as accessories available

²⁾ incl. in the scope of supply

Order Information

CERTIFIED
ISO 9001



Figure	Ord.-No.	Product-Description
	23480131	Thickness Measuring Instrument PAINT BORER 518 USB Included in the scope of supply <ul style="list-style-type: none"> ◆ drill no. 5 ◆ 2 felt tip pens (black/silver) ◆ screw driver ◆ rechargeable battery (9 V) ◆ power pack (100 - 240) VAC, (47 - 63) Hz ◆ software (USB-stick) ◆ calibration standard ◆ plastic case ◆ manual
	02830131	Thickness Measuring Instrument PAINT BORER 518 MC Included in the scope of supply: <ul style="list-style-type: none"> ◆ drill no. 5 ◆ 2 felt tip pens (black/silver) ◆ screw driver ◆ rechargeable battery (9 V) ◆ power pack (100 - 240) VAC, (47 - 63) Hz ◆ plastic case ◆ manual
	02800131	Thickness Measuring Instrument PAINTXPLORER 548 Included in the scope of supply: <ul style="list-style-type: none"> ◆ drilling stand ◆ drill no.5 ◆ 2 felt tip pens (black/silver) ◆ screw driver ◆ tool for change of drills ◆ power pack (100 - 240) VAC, (47 - 63) Hz ◆ plastic case ◆ manual
Accessories		
	910927141	Drill No. 1 (up to 2000 µm)
	910927241	Drill No. 2 (up to 200 µm)
	910927841	Drill No. 3 (up to 1000 µm)
	910927741	Drill No. 4 (up to 500 µm)
	910928241	Drill No. 5 (up to 300 µm) – Spare part
	24600132	Specimen platform for fixation/measurement of small parts (for models 518 MC / 518 USB)
	08360132	Measuring microscope 456-50 with illumination (for PAINTXPLORER 548)